

Article number: 33214525040

Description: Oldham coupling hub 452H50.40 ALU
with clamp hub and through bore, bore 15 mm

Measures

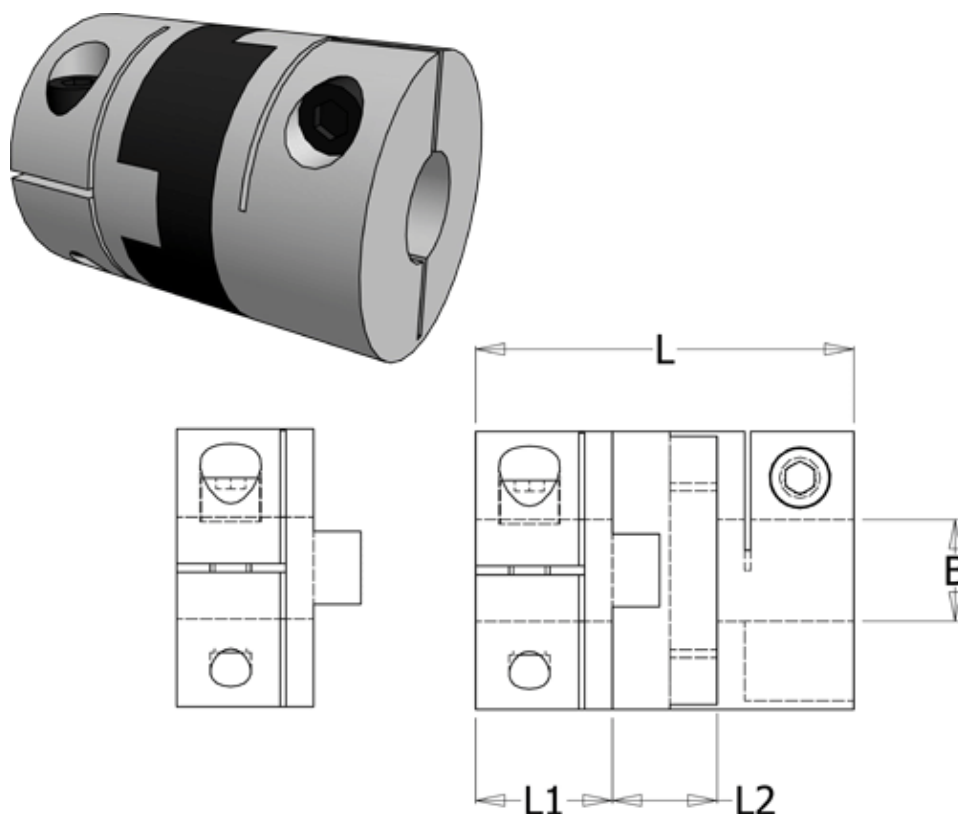

B1	= 15
D	= 50
L	= 59.6
L1	= 20.6
L2	= 18.4

Note: Overnævnte varenr. er kun for et koblingsnav. Der går 2 koblingsnav og 1 element til 1 komplet kobling

Screw = M5

Torque (Nm) = 30